

**Finish/color code must be specified when ordering.

**ระบุรหัสวัสดุเคลือบผิว/สีในการสั่งซื้อผลิตภัณฑ์

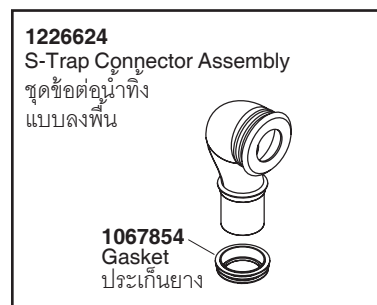
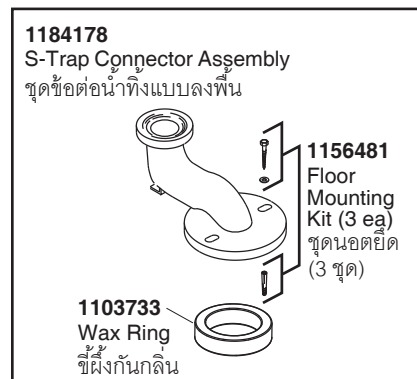
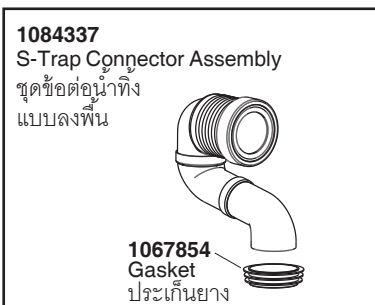
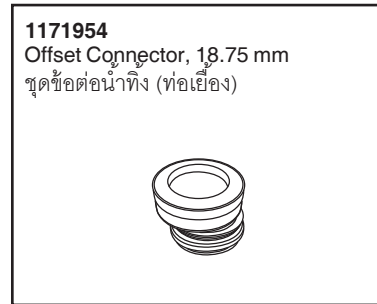
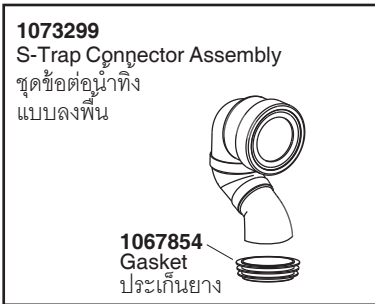
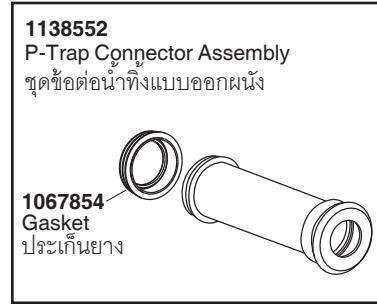
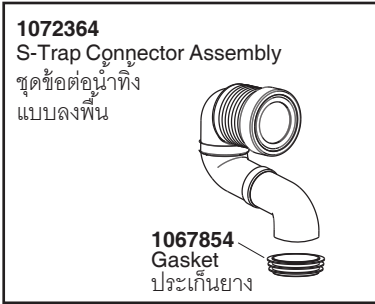

**Finish/color code must be specified when ordering.

**ระบุรหัสสีวัสดุเคลือบผิว/สีในการสั่งซื้อผลิตภัณฑ์

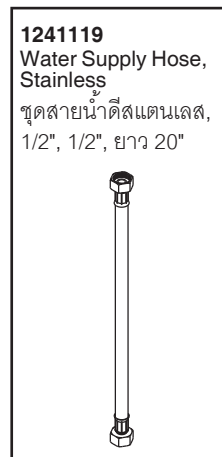
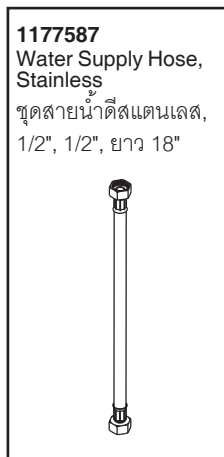
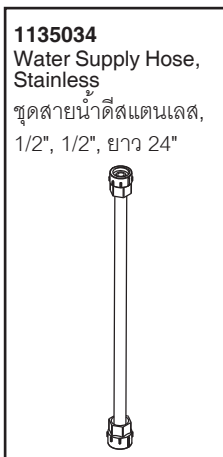
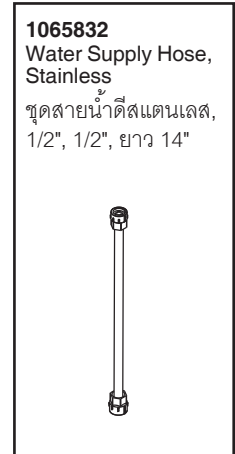
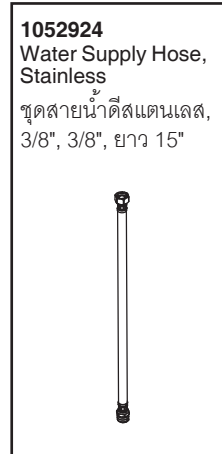
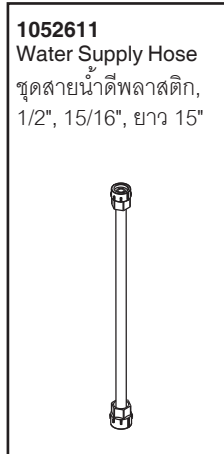
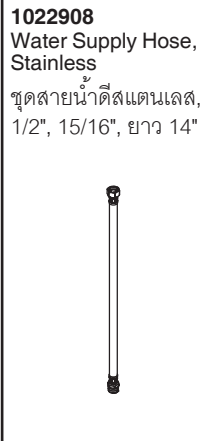

**Finish/color code must be specified when ordering.

**ระบุรหัสสี/สีเคลือบผิว/สีในการสั่งซื้อผลิตภัณฑ์