

Dimensions are approximate.  
Unit: mm.

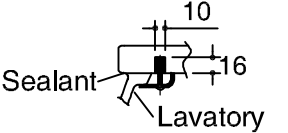

Mable Installation

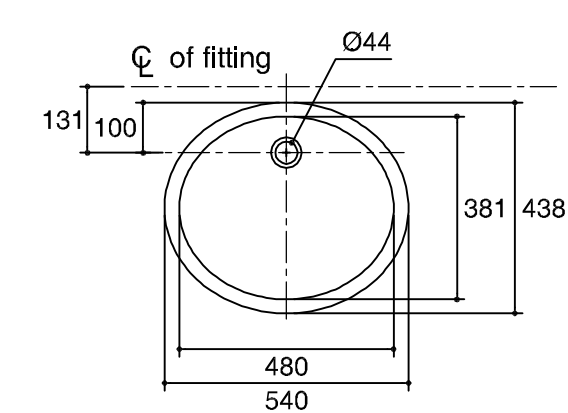
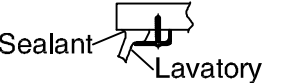

Wood Installation

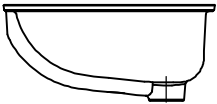
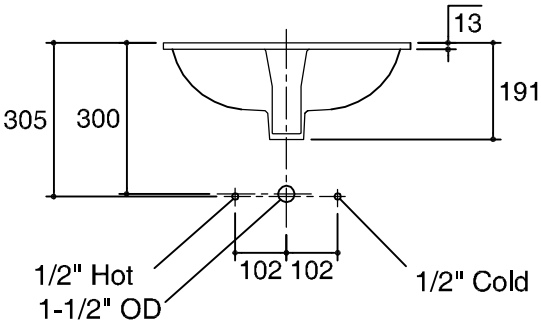

SKU	K-2211X-0
Name	CAXTON
Description	LAVATORY

**KOHLER**

\* The recommended dimension for installation can be adjusted according to user preferences and layout.